



Atlas Workholding 3 Jaw Open Center 'Long Stroke' Power Chuck

ALS 6" - 12" Chucks

- ⊕ Extended jaw stroke
- ⊕ ± .0005 repeatability
- ⊕ 1.5mm x 60° master jaws
- ⊕ All steel body
- ⊕ Hardened jaw ways, master jaws and internal parts
- ⊕ Open center

Model No.	Thru Hole Dia	Jaw Stroke Dia	Sleeve Stroke	Gripping Capacity		Draw Bar Pull lb/f	Grip Force lb/f	Max RPM	Wt lbs
				Max	Min				
ALS6-A5 (D)	1.102"	.787"	.590"	6.49"	1.102"	6,272	7,015	4500	31
ALS8-A6 (D)	1.771"	.984"	.748"	8.46"	1.259"	9,239	11,016	3300	55
ALS8-A8 (I)	1.771"	.984"	.748"	8.46"	1.259"	9,239	11,016	3300	55
ALS10-A6 (I)	2.086"	1.181"	.866"	10.00"	1.653"	12,094	14,169	3000	99
ALS10-A8 (D)	2.086"	1.181"	.866"	10.00"	1.653"	12,094	14,169	3000	99
ALS12-A6 (I)	2.480"	1.377"	.984"	11.96"	1.692"	15,579	18,075	2200	172
ALS12-A8 (D)	2.480"	1.377"	.984"	11.96"	1.692"	15,579	18,075	2200	172
ALS12-A11 (I)	2.480"	1.377"	.984"	11.96"	1.692"	15,579	18,075	2200	172

(I) Indirect mount (D) Direct mount

Dimensional Data (in inch)

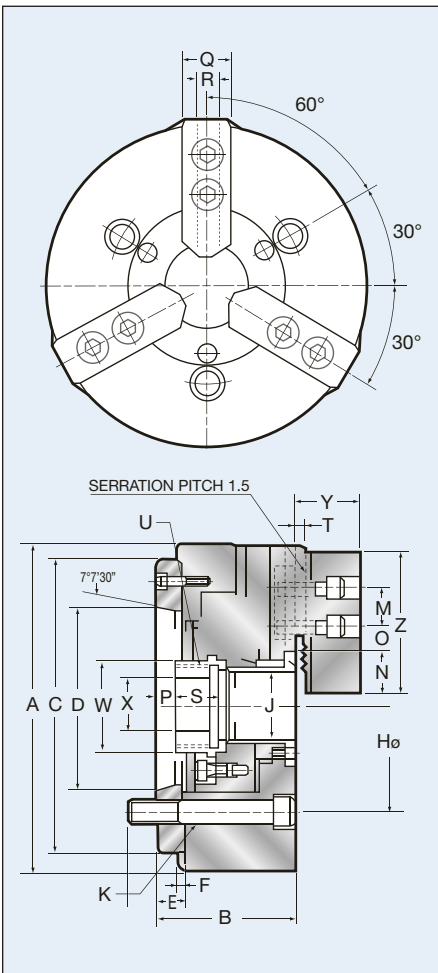

MODEL	ALS6-A5	ALS8-A6	ALS8-A8	ALS10-A6	ALS10-A8	ALS12-A6	ALS12-A8	ALS12-A11
A	6.65	8.46	8.46	10.00	10.00	11.97	11.97	11.97
B	5.91	6.69	7.17	5.20	5.24	9.45	9.17	9.33
C	5.512	6.693	6.693	8.661	8.661	8.661	8.661	8.661
D	3.250	4.188	5.501	4.188	5.501	4.188	5.501	7.751
E	.622	.699	.738	1.014	.738	.945	.669	.827
F	.197	.197	.197	.197	.197	.197	.197	.197
H	4.126	5.252	6.748	5.252	6.748	5.252	6.748	9.250
J	1.102	1.771	1.771	2.086	2.086	2.480	2.480	2.480
K	M10	M12	M16	M12	M16	M12	M16	M20
M	.787	.984	.984	1.181	1.181	1.181	1.181	1.181
N max.	1.545	2.086	2.086	2.460	2.460	2.933	2.933	2.933
N min.	1.151	1.594	1.594	1.870	1.870	1.244	1.244	1.244
O max.	.659	.817	.817	1.053	1.053	1.505	1.505	1.505
O min.	.364	.462	.462	.443	.443	.502	.502	.502
P max.	.394	.118	.118	.236	.236	.323	.323	.323
P min.	.197	-.630	-.630	-1.102	-1.102	-.661	-.661	-.661
Q	1.023	1.378	1.378	1.575	1.575	1.969	1.969	1.969
R	.472	.551	.551	.630	.630	.826	.826	.826
S	.945	1.260	1.260	1.575	1.575	1.496	1.496	1.496
T	.079	.079	.079	.079	.079	.118	.118	.118
U max.	M38x1.5	M55x2.0	M55x2.0	M65x2.0	M65x2.0	M75x2.0	M75x2.0	M75x2.0
W	1.771	2.560	2.560	2.874	2.874	3.268	3.268	3.268
X	.787	1.181	1.181	1.771	1.771	1.968	1.968	1.968
Y	1.141	1.535	1.535	1.693	1.693	2.047	2.047	2.047
Z	2.598	3.740	3.740	4.331	4.331	4.370	4.370	4.370

HOW TO ORDER: State quantity, Model Number of chuck and shipping instructions.